



VOLTCRAFT®

**Energiekostenmessgerät
Energy Logger 4000**

Ⓓ **BEDIENUNGSANLEITUNG**

Seite 4 - 20

**Energy cost measuring device
Energy Logger 4000**

ⒼⒷ **OPERATING INSTRUCTIONS**

Page 21 - 37

**Energiekostenmeetapparaat
Energy logger 4000**

ⒹⒻ **GEBRUIKSAANWIJZING**

Pagina 38 - 54

Best.-Nr. / Item-No. /

Bestnr.:

12 54 44

CE

Version 03/12

- D** Diese Bedienungsanleitung gehört zu diesem Produkt. Sie enthält wichtige Hinweise zur Inbetriebnahme und Handhabung. Achten Sie hierauf, auch wenn Sie dieses Produkt an Dritte weitergeben.

Heben Sie deshalb diese Bedienungsanleitung zum Nachlesen auf!

Eine Auflistung der Inhalte finden Sie in dem Inhaltsverzeichnis mit Angabe der entsprechenden Seitenzahlen auf Seite 5.

- GB** These operating instructions belong with this product. They contain important information for putting it into service and operating it. This should be noted also when this product is passed on to a third party.

Therefore look after these operating instructions for future reference!

A list of contents with the corresponding page numbers can be found in the index on page 22.

- NL** Deze gebruiksaanwijzing hoort bij dit product. Er staan belangrijke aanwijzingen in betreffende de ingebruikname en gebruik, ook als u dit product doorgeeft aan derden.

Bewaar deze handleiding zorgvuldig, zodat u deze later nog eens kunt nalezen!

U vindt een opsomming van de inhoud in de inhoudsopgave met aanduiding van de paginnummers op pagina 39.

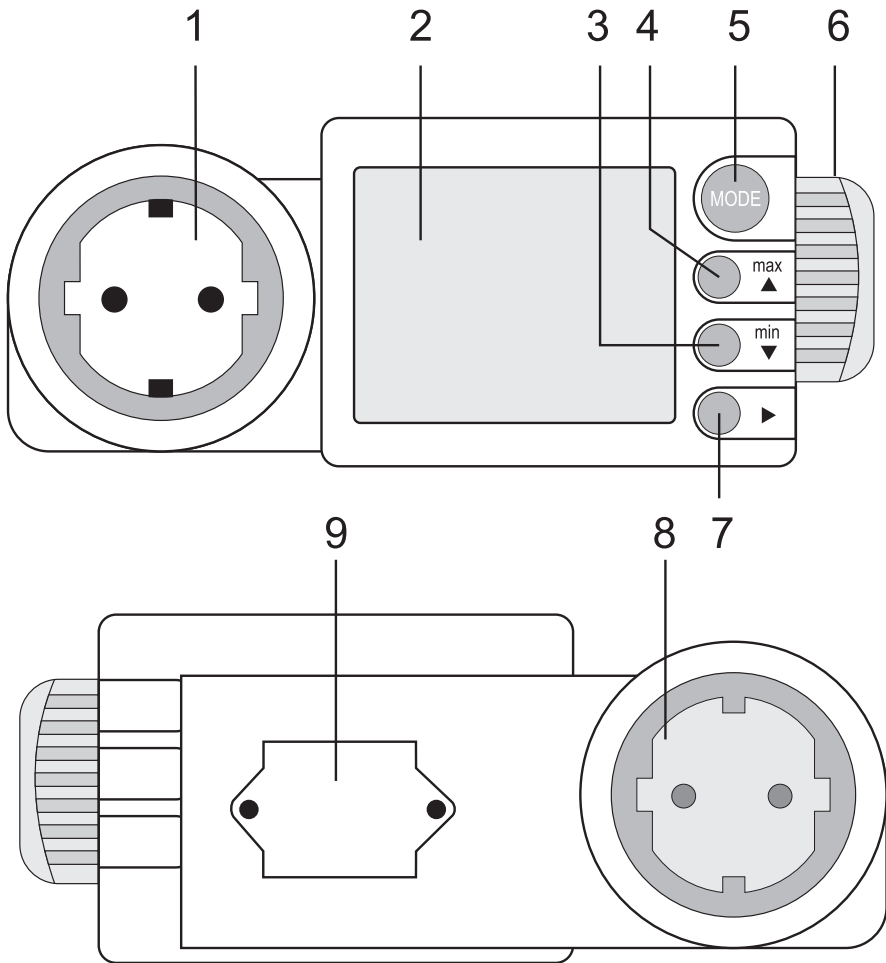

Introduction

Dear customer,

Thank you for making the excellent decision to purchase this Voltcraft® product.

You have acquired a quality product from a brand family which has distinguished itself in the fields of measuring, charging and network technology thanks to its particular expertise and its permanent innovation.

The products of the Voltcraft® family offer optimum solutions even for the most demanding applications for ambitious hobby electricians as well as for professional users. Voltcraft® offers you reliable technology at an extraordinarily favourable cost-performance ratio.

Therefore, we are absolutely sure: Your decision for a Voltcraft product is the beginning of a long and successful cooperation.

And now enjoy your new Voltcraft® product!

Table of contents

Introduction	21
Intended use	23
Operating elements	24
Safety instructions	24
Product description	26
Scope of delivery	26
Display Indications and Symbols	27
Commissioning	28
Basic settings.....	28
a) Select device ID.....	28
b) Time settings	28
c) Tariff settings	29
Measuring mode	29
a) „Power1“ display for current, power and frequency	29
b) „Power2“ display for effective power, output and performance factor	30
c) „Consumption“ display for overall power consumption	30
d) „History“ display for energy consumption per day	31
e) „ON time“ display for operating time per day	31
f) „Forecast“ display for cost preview	32
g) „Time“ display for time and date display	32
Data transmission	32
Delete „MEM“ data memory	33
Install software	34
Maintenance and cleaning.....	34
Inserting and changing the battery	34
Disposal	36
Troubleshooting	36
Technical data	37

Intended use

The energy cost measuring device serves to measure and analyse consumption details of electrical devices. The measuring device is simply connected between the mains socket and the electric device and requires no additional installation. Operation is only allowed at standard household protection mains sockets with a nominal current of 230 V/AC. The max. nominal performance must not exceed 3500 watts. If the product is overloaded, it may be damaged. The warranty/guarantee will become void in these cases. Do not plug together several energy cost measuring instruments.

The measuring device has an internal, non-volatile memory where the data for performance factor, current and power can be saved for up to 6 months. Via an SDHC card slot this data can be transferred to a computer for analysis.

Two additional freely programmable tariffs are available for cost calculation. The device also calculates a cost preview per month and year. The consumption data can also be displayed directly on the device retroactively up to 9 days.

The measuring device is not officially calibrated and must therefore not be used for balancing purposes.

A buffer battery supplies the internal clock when switched off. The device may only be operated with the specified batteries.

The measuring instrument must not be operated when it is open, i.e. with an open battery compartment or when the battery compartment cover is missing. Measuring in damp rooms or under unfavourable ambient conditions is not admissible.

Unfavourable ambient conditions are:

- Wet conditions or high air humidity
- Dust and flammable gases, vapours or solvent,
- Thunderstorms or similar conditions such as strong electrostatic fields etc.

Any use other than the one described above damages the product. Moreover, this involves dangers such as e.g. short circuit, fire, electric shock, etc. No part of the product must be modified or rebuilt!

Read the operating instructions carefully and retain them for later reference.

The safety instructions must be observed at all times.

Operating elements

See fold-out section

- 1 Protection mains socket (output)
- 2 Display (LCD)
- 3 min key with up function (Up)
- 4 max key down up function (Down)
- 5 MODE key to switch displays
- 6 Lateral SDHC card slot
- 7 Selection key for settings and data transfer
- 8 Protection key socket (input)
- 9 Rear compartment for buffer battery

Safety instructions



Please read the entire operating instructions before using the product for the first time; they contain important information regarding the correct operation.

The guarantee is rendered invalid when damage occurs as a result of non-compliance with the operating instructions! Liability for any and all consequential damage is excluded!

We do not assume any liability for material and personal damage caused by improper use or non-compliance with the safety instructions! Under these circumstances, any warranty expires.

This device left the manufacture's factory in a safe and perfect condition.

We kindly request that you as a user observe the safety instructions and warnings contained in this operating manual to preserve this condition and to ensure safe operation!

Please observe the following symbols:



A triangle containing an exclamation mark indicates important information in these operating instructions which are to be observed without fail.



The triangle containing a lightning symbol warns of danger of an electric shock or of the impairment of the electrical safety of the device.



The „hand“ symbol is used to indicate where specific hints and information on handling should be given.

CAT II

The device corresponds to the excess-voltage category II for implementation in devices that are directly connected to the public grid via a mains plug.



This product has been CE-tested and meets the necessary European guidelines.



Only to be used in dry indoor areas.

The unauthorised conversion and/or modification of the unit is inadmissible because of safety and approval reasons (CE).

Consult an expert when in doubt about the operation, the safety or the connection of the device.

Measuring instruments and accessories are not toys and have no place in the hands of children.

On industrial sites the accident prevention regulations of the association of the industrial workers' society for electrical equipment and utilities must be followed.

In schools, training centres, computer and self-help workshops, handling of measuring instruments must be supervised by trained personnel in a responsible manner.

Be especially careful when dealing with voltages higher than 25V AC or 35 V DC. Even at such voltages you can receive a life-threatening electric shock when you come into contact with electric wires.

Prior to each measurement, check your instrument for damage. Never carry out any measurements if the protecting insulation is defective (torn, ripped off etc.)

Do not use the meter immediately prior to, during or just after an electrical storm (electrical shock risk! / high-energy overvoltages!). Please make sure that your hands, your shoes, your clothing, the floor, switches and switching components are dry.

The measurement may be distorted. Avoid an operation near:

- strong magnetic or electromagnetic fields
- transmitter aeriels or HF generators,

If you have a reason to believe that the device can no longer be operated safely, disconnect it immediately and secure it against being operated unintentionally. It can be assumed that safe operation is no longer possible if:

- the device is visibly damaged,
- the device no longer works and
- the unit was stored under unfavourable conditions for a long period of time or
- if it has been subjected to considerable stress in transit.

Do not switch the measuring instrument on immediately after it has been taken from a cold to a warm environment. Condensation that forms might destroy your device. Allow the device to reach room temperature.

Do not leave the packaging material lying around carelessly since such materials can become dangerous toys in the hands of children.

You should also heed the safety instructions in each chapter of these instructions.

Product Description

The Energy Logger 4000 shows all data established on a concise display. The following displays are possible:

- Clamping (V), electricity (A) and frequency (Hz), user type (load, burden/capacity load)
- Effective power (W), output (VA) and performance factor (cosPHI)
- Min/max recording of V, A, Hz, W, VA and cosPHI
- Overall consumption (kWh), usage costs (cost) tariffs 1 and 2
- Daily consumption (kWh, cost1/2), retroactively up to 9 days
- Recording time (REC time) and operating time (ON time)
- Cost preview per month and year
- Time and date display
- Display of the remaining memory size (MEM in %)



The measurement device can be used in the hoggly and professional area, but must not be used for balancing purposes.







Prior to working with the measuring device, you first have to insert the enclosed batteries.

Insert the battery as described in Section „Cleaning and Maintenance“. To buffer time and date, a lithium cell type CR1620 is required. These are supplied with the device.

Contents

Measuring device with cell
Software CD with evaluation software
Operating instructions

Display indications and symbols

	Up symbol
	Down symbol
	Continue symbol
MODE	Mode switching (measurement display)
max/min	Maximum/minimum value display
MEM 0 - 99%	Remaining size of the internal memory
ID 0 - 9	Consumer number, up to 10 consumers can be managed
Power1/2	Display of current values
Consumption	Display of the recording data of electric consumption
Total	Total value
cost1/2	Cost display for tariff 1 or 2
History today	Display of the recorded data for today or up to 9 days in the past
REC time h	Recording time in hours, since the measuring device was plugged in
ON time h	Actual operating time of electric consumption, e.g. for fridges
Forecast	Calculative preview
cost/m	Cost forecast per month (for tariffs 1 or 2)
cost/y	Cost forecast per year (for tariffs 1 or 2)
Time	Display of time and date
	Symbol for connected SDHC card
V	Volt (unit of electric potential)
A	ampere (unit of electric current)
Hz	Hertz (unit of frequency)
W	Watt (unit of effective power)
VA	Volt ampere (unit of output, without reference to the performance factor)
cosPHI	Performance factor (factor of phase shift)
kWh	Kilowatt hours (units of electrical work)
	Symbol for capacity load
	Symbol for inductive burden

Initial Operation



**Do not exceed the maximum permitted input values.
Before measuring, check the measuring device for damage such as cuts, cracks or squeezing. A defective device must not be used. Mortal danger!**

Before using for the first time, the enclosed buffer battery be inserted for the time and date. Inserting and changing the battery can be found in Section „Maintenance and Cleaning“.

After inserting the buffer battery, connect the measuring device in a standard protection socket. The measuring device is ready for programming or operation.

Basic settings

After the first use, some parameters must be preset to allow a correct display. You can reach this mode by pressing the „MODE“ and „Continue“ keys (7) for at least 2 seconds simultaneously. You now reach the „Select device ID“ menu item.

a) Select ID device

This equipment ID number allows you to administer up to 10 electrical users on one meter unit. In the adjustment mode the ID number blinks in the right upper display. Choose the desired identification number (ID 0-9 with the buttons “min” (3) and “max” (4) and confirm your choice with the button “MODE” (5). The machine will then send you automatically to the next mode, “time setting.”

b) Time settings

First you select the the desired time format (12/24-h system) with the two arrow keys (3 and 4) and confirm your selection with the „MODE“ key (5).

Select the date format with the two arrow keys (3 and 4). Available are:

dd.mm.yyyy for day/month and year or

mm.dd.yyyy for month/day and year

Confirm the selection by pressing the “MODE” (5) key. You will automatically reach the next mode.

The hours display of the time flashes. Set the correct time with the arrow keys (3 and 4). After entering the hours, you reach the minute input by pressing the „Continue“ arrow key (7). Repeat these steps until you have set day, month and year.

Confirm your settings in the year mode by pressing the “MODE” (5) key. The time starts to run and you automatically reach the next mode.

c) Tariff settings

First select the desired currency (€, £, SFr or \$, applies for both tariffs) with the two arrow keys. With the „Continue“ arrow key (7) you can set the first tariff. The arrow keys (3 and 4) change the value, the „Continue“ arrow key (7) changes the decimal position. Repeat these steps until the second tariff is also set. The comma cannot be changed.

Confirm your settings after the last figure of the 2nd tariff with the „MODE“ key (5). The basic settings are saved and you automatically reach the normal measuring operation.

Measuring operation

Due to the many display functions, the measuring values can only be displayed via several displays. Up to three values can be displayed simultaneously.

To switch the measurement displays, click the „MODE“ (5) key for the next or the „Continue“ arrow key (7) for the previous display. Every time you press, you switch the display.



After switching on the electric consumer, the energy cost measurement device needs a couple of seconds to display the measurement values. During this time all required parameters are measured and calculated.

The energy cost measurement value records from the time of launching the data for current, power and performance factor without interruption, but for a maximum of 6 months. The free memory in the internal memory is illustrated by a percentage display next to „MEM“.

a) „Power1“ display for current, power and frequency

After connecting the measurement device, this display is always shown. In the bottom right corner the load type (capacity/resistance) can also be seen as a symbol. If no device is connected, no symbol appears.

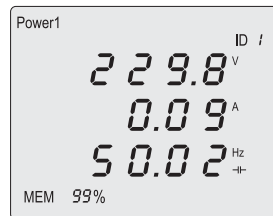

The maximum and minimum values are saved by the measuring device automatically. Via the „max“ (4) or „min“ (3) keys, the values are displayed for approx. 10 seconds. Pressing the key again switches back to the normal display prematurely.

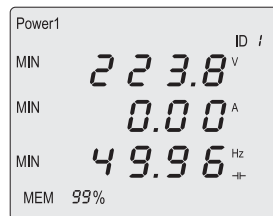
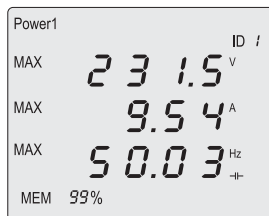



In order to delete the MAX/MIN memory, keep the two „min“ and „max“ pressed simultaneously for approx. 2 seconds. The data is deleted if „MAX/MIN“ appears on the display simultaneously.

To switch the measurement displays, click the „MODE“ (5) key for the next or the „Continue“ arrow key (7) for the previous display. Every time you press, you switch the display.

b) „Power2“ display for effective power, output and performance factor

The „W“ effective power displays the actually assumed load. The effective power is established from the three parameters of current, power and performance factor „cosPHI“.

The „VA“ output, however, establishes only the product from current and power, which can result in a deviation from the effective power to the output for capacity loads.

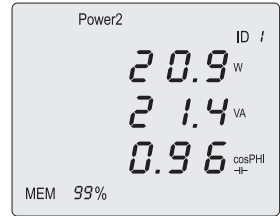

Your energy supplier always assumes the effective power as the basis for calculation (the measurement device is not approved for balancing purposes!).

The MIN/MAX display is carried out as described in the „Power1“ display.

To switch the measurement displays, click the „MODE“ (5) key for the next or the „Continue“ arrow key (7) for the previous display. Every time you press, you switch the display.

c) „Consumption“ display for overall power consumption

This display shows the entire, already used energy in kilowatt hours and the thus calculated costs for tariffs 1 and 2.



Your energy supplier always states your energy consumption and the tariff costs in kilowatt hours (kWh) (The measuring device is not approved for balancing purposes!).

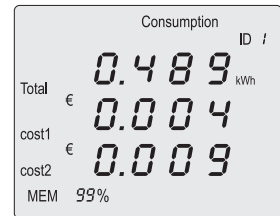

In order to read the preset tariff values for tariffs 1 and 2, press the „max“ key once. The display switches back after approx. 5 seconds.

By pressing the „MODE“ key for at least 3 seconds, all displays of „Consumption“, „History“, „ON time“ and „Forecast“ are reset to null, and the „MEM“ memory deleted.

To switch the measurement displays, click the „MODE“ (5) key for the next or the „Continue“ arrow key (7) for the previous display. Every time you press, you switch the display.

d) „History“ display for energy consumption per day

This display shows the already used energy in kilowatt hours „kWh“ and the thus calculated costs for tariffs 1 and 2. The display can be differentiated from the current day (today) until 9 days in the past. Via the two arrow keys (3 and 4) the days can be browsed back and forwards. This is illustrated under the display masking „Today“, e.,g. as „1“ to „9“.

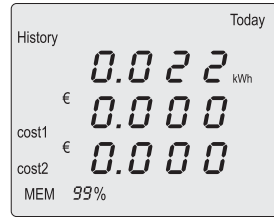

Via this function peak days can be directly analysed on the device.

By pressing the „MODE“ key for at least 3 seconds, all displays of „Consumption“, „History“, „ON time“ and „Forecast“ are reset to null, and the „MEM“ memory deleted.

To switch the measurement displays, click the „MODE“ (5) key for the next or the „Continue“ arrow key (7) for the previous display. Every time you press, you switch the display.

e) „ON time“ display for operating time per day

This display shows the operating time (REC time) and the effective running time (ON time) of the electric consumption. This function allows establishing the actual running time, such as with a fridge. A fridge switches the cooling circuit on with a thermostat, which results in pauses.

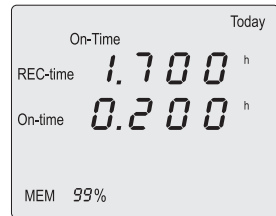

The display can be differentiated from the current day (today) until 9 days in the past.

Via the two arrow keys (3 and 4) the days can be browsed back and forwards. This is illustrated under the display masking „Today“, e.,g. as „1“ to „9“. After the „-9“ display, the entire time (total) is displayed.



Via this function peak days can be directly analysed on the device. The time is displayed in the decimal system. Example: 1,700 h = 1 h 42 m (700 : 16.66 = 42 minutes).

By pressing the „MODE“ key for at least 3 seconds, all displays of „Consumption“, „History“, „ON time“ and „Forecast“ are reset to null, and the „MEM“ memory deleted.

To switch the measurement displays, click the „MODE“ (5) key for the next or the „Continue“ arrow key (7) for the previous display. Every time you press, you switch the display.

f) Forecast cost preview display

The cost preview allows establishing by calculation the costs for a month or the entire year. The calculation can be switched for tariffs 1 and 2 and is carried out via the two arrow keys (3 and 4).



The already used energy (total in kWh) is used as the basis of the calculation. This calculated value is only an idea which represents the possible cause. Short measurement breaks or changed power prices can result in deviations. The measurement device is not approved for balancing purposes.

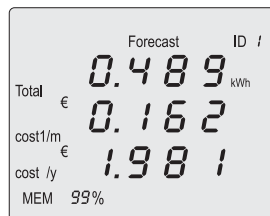

By pressing the „MODE“ key for at least 3 seconds, all displays of „Consumption“, „History“, „ON time“ and „Forecast“ are reset to null, and the „MEM“ memory deleted.

To switch the measurement displays, click the „MODE“ (5) key for the next or the „Continue“ arrow key (7) for the previous display. Every time you press, you switch the display.

g) „Time“ display for time and date display

The time and date are displayed in the display mode. By pressing the „max“ key (4), the time and date format can be controlled. The display switches back automatically after approx. 5 seconds to the normal display.

To switch the measurement displays, click the „MODE“ (5) key for the next or the „Continue“ arrow key (7) for the previous display. Every time you press, you switch the display. After the last display, it starts again at the „Power1“ display.

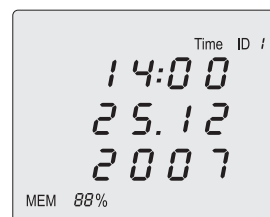

Data transmission

The energy cost measurement device has an internal, non-volatile data memory with a capacity of up to 6 months. The display shows the remaining capacity in %. If this value drops to 2%, the MEM display starts flashing. It is now necessary to read out and delete the required data memory, as otherwise no data can be recorded.



During data transmission, the measurement device can be operated for measurement conversion. The SDHC card must not be removed or the measurement device unplugged. This results in a risk of data loss.

An optional SDHC card with the following characteristics is required for reading out:

- memory size at least 512 MB, max. 32 GB (4 GB recommended)
- storage format FAT 32
- not write-protected
- Minimum 5 MB free storage capacity
- energy data previously saved on the card must be deleted

Proceed as follows to start data transmission:

- Pull the plastic cover on the SDHC card shaft unit (6) out to the side.
- Insert the optional SDHC card in the slot as illustrated. The chamfered corner points downwards.
- Push the card shaft unit into the machine.
- The SDHC card symbol is displayed. If the symbol cannot be seen, check whether the card is fully inserted.
- Press the „Continue“ arrow key (7) in order to start data transmission. A flashing arrow signals data transmission and the memory information runs from 0 to 99%.
- The data is transferred to the card. Depending on the use of various SDHC cards and the size of the stored data, this can lead to a longer data transfer sequence, although the machine already shows that the storage has been completely accomplished. For this reason, you should leave the SDHC card several seconds in the energy logger, even after the display indicates that the transfer has been completed. Then the SDHC card can be removed. Close the cover of the SDHC card drive (6).

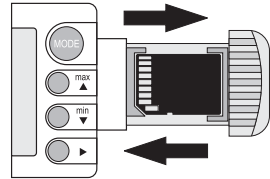

To switch the measurement displays, click the „MODE“ (5) key for the „Continue“ arrow key (7). Every time you press, you switch the display.

Delete „MEM“ data memory

The internal, non-volatile data memory can only be deleted manually. This is practical after every data transmission or before a new measurement of an electric device.

By pressing the „MODE“ key for at least 3 seconds, all displays of „Consumption“, „History“, „ON time“ and „Forecast“ are reset to null, and the „MEM“ memory deleted.

An empty data memory is signalled with a „MEM 99%“ display.

Software installation

1. Insert the CD into the CD-ROM of your computer.
2. The installation will start automatically. If not, please go to your CD-ROM directory and open the installation file "autorun.exe".
3. Select your desired language from German, English and French.
4. Follow the instructions on the dialog box, select the destination for the installation and complete the installation.
5. For further information, please refer to the operating instructions on the CD provided.

Note: It is available to keep software update to the latest version as Voltsoft program is running and internet access is connected; or check the latest version information of Voltsoft update via "<http://www.conrad.com>"

Maintenance and cleaning

General

Apart from occasional cleaning and battery replacements, the measurement device requires no servicing. The battery change is described below.



Regularly check the technical safety of the device e.g. for damage to the housing, etc.

Cleaning

Always observe the following safety instructions before cleaning the device:



Live components may be exposed if covers are opened or parts are removed (unless this can be done without tools).

Before cleaning or repairs, a connected electric device must be disconnected from the measurement device and the measurement device itself disconnected from the mains socket.

Do not use any carbon-containing cleaning agents or petrol, alcohol or the like to clean the product. These could corrode the surface of the measuring instrument. The fumes are furthermore a health hazard and are explosive. Moreover, you should not use sharp-edged tools, screwdrivers or metal brushes or similar for cleaning.

To clean the device or the display, use a clean lint-free anti-static and dry cleaning cloth.

Inserting and changing the batteries

Operation of the measuring device requires a 3V battery (type CR1620). A new battery must be installed before the first start up or when the time and date are not retained when the unit has been unplugged.



Battery replacing must not take any longer than 2 minutes, such as not to lose the data memory for time and date. Prepare the suitable tool and the new battery in order to carry out the battery replacement quickly.

To insert/replace the battery, proceed as follows:

- Disconnect the measurement device from the mains socket.
- Loosen the two screws on the reverse side of the battery cover and lift off the battery cover.
- Now put the new battery with a correct polarity into the battery compartment. The plus pole of the battery will point outwards.
- Set the battery compartment cover correctly on the device and lock the housing again carefully.

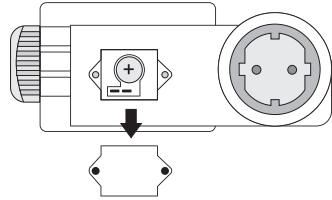

Never operate the measuring instrument when it is open. !RISK OF FATAL INJURY!



Do not leave flat batteries in the appliance. Even batteries protected against leaking can corrode and thus release chemicals which may be detrimental to your health or damage the appliance.

Do not leave batteries lying around carelessly. They might be swallowed by children or pets. If swallowed, consult a doctor immediately.

Remove the batteries if the device is not used for longer periods of time to prevent leaking.

Leaking or damaged batteries may cause alkali burns if they come in contact with the skin. Therefore, use suitable protective gloves.

Make sure that the batteries are not short-circuited. Do not throw batteries into fire!

Batteries may not be recharged. There is a danger of explosion.



A compatible lithium battery of the CR1620 type can be obtained with the following purchase number: Item no. 12 53 56 (please order once).

Disposal



Old electronic devices are hazardous waste and should not be disposed of in the household waste. When the device has become unusable, dispose of it in accordance with the current statutory regulations at the communal collection points. Disposal in the domestic waste is not permitted.

Disposal of flat batteries.

You, as end user are legal obliged (**Battery Regulation**) to return all used batteries and rechargeable batteries; **disposal of them in domestic waste is not permitted!**



Batteries/rechargeable batteries containing harmful substances are marked with the following symbols, indicating that it is not permitted to dispose of them in the domestic refuse. The symbols for dangerous heavy metal constituents are: **Cd** = Cadmium, **Hg** = Mercury, **Pb** = Lead. You can return dead batteries free of charge to the collection points in your community, our branches or anywhere else where batteries are sold.



You thus fulfil the legal requirements and make your contribution to the protection of the environment!

Troubleshooting

In purchasing the Energy Logger 4000, you have acquired a product which has been designed to the state of the art and is operationally reliable.

Nevertheless, problems or faults may occur. For this reason, the following is a description of how you can eliminate possible malfunctions yourself.



Please always observe the safety instructions!

Error	Possible cause	Remedy
Data transmission to SDHC card does not start	The card symbol is not in the display.	Insert the card until end of the card slot.
	The card symbol is flashing. The card is full or does not correspond with the requirements (size, format).	Loosen the card or replace it.

Error	Possible cause	Remedy
No operation possible.	You are mode „Data transmission“.	After the end of the data transmissions remove the SDHC card from the measurement device.
No data memor any more available (MEM < 2%).	The internal data memory is full.	Back up the data on a SDHC card and delete the data memory.



Repairs other than those just described should only be performed by an authorised specialist.

If you have queries concerning use of the measuring device, our technical support service is available at the following telephone number:

**Voltcraft®, 92242 Hirschau, Lindenweg 15,
Phone 0180 / 586,582,723 8**

Technical data

Operating voltage	230 V/AC 50/60 Hz
Max. power/current	3500 W/15 A
Performance measurement display	0.1 -3500 W
Display energy use	0.000 - 9999 kWh
Display	three lines with 4 positions each
Tariff range	0,000 - 9,999
Accuracy	5 - 3500 W ($\pm 1\% + 1$ count) 2 -5 W ($\pm 5\% + 1$ count) < 2 W ($\pm 15\% + 1$ count)
Buffer battery	3 V, CR1620
Ambient conditions	10 - 50 °C/max. 90%rH (not condensing) Operating altitude: max. 2000 m (above MSL)
Weight	ca. 240 g
Dimensions (LxWxH)	164 x 82 x 83 (mm)
Overvoltage category	CAT II
Pollution degree	2

Measurement tolerances

Statement of accuracy in \pm (% of reading + display error in counts (= number of smallest points)). The accuracy is valid at a temperature of $+23^{\circ}\text{C} \pm 5^{\circ}\text{C}$, and at a relative humidity of less than 75 %, non-condensing.



In no event exceed the max. permitted input values.

VOLTCRAFT IM INTERNET <http://www.voltcraft.de>

D Impressum

Diese Bedienungsanleitung ist eine Publikation von Voltcraft®, Lindenweg 15, D-92242 Hirschau, Tel.-Nr. 0180/586 582 7 (www.voltcraft.de).
Alle Rechte einschließlich Übersetzung vorbehalten. Reproduktionen jeder Art, z.B. Fotokopie, Mikroverfilmung, oder die Erfassung in elektronischen Datenverarbeitungsanlagen, bedürfen der schriftlichen Genehmigung des Herausgebers. Nachdruck, auch auszugsweise, verboten.
Diese Bedienungsanleitung entspricht dem technischen Stand bei Drucklegung. Änderung in Technik und Ausstattung vorbehalten.

© Copyright 2012 by Voltcraft®

GB Legal notice

These operating instructions are a publication by Voltcraft®, Lindenweg 15, D-92242 Hirschau/Germany, Phone +49 180/586 582 7 (www.voltcraft.de).

All rights including translation reserved. Reproduction by any method, e.g. photocopy, microfilming, or the capture in electronic data processing systems require the prior written approval by the editor. Reprinting, also in part, is prohibited.

These operating instructions represent the technical status at the time of printing. Changes in technology and equipment reserved.

© Copyright 2012 by Voltcraft®

NL Colofon

Deze gebruiksaanwijzing is een publicatie van de firma Voltcraft®, Lindenweg 15, D-92242 Hirschau/Duitsland, Tel. +49 180/586 582 7 (www.voltcraft.de).

Alle rechten, vertaling inbegrepen, voorbehouden. Reproducties van welke aard dan ook, bijvoorbeeld fotokopie, microverfilmung of de registratie in elektronische gegevensverwerkingsapparatuur, vereisen de schriftelijke toestemming van de uitgever. Nadruk, ook van uittreksels, verboden.

Deze gebruiksaanwijzing voldoet aan de technische stand bij het in druk bezorgen. Wijziging van techniek en uitrusting voorbehouden.

© Copyright 2012 by Voltcraft®

V2_0312_01/AB

VOLTCRAFT®

Ⓧ WICHTIGER HINWEIS

VOLTSOFT-SOFTWARE

Sehr geehrte Kundin, sehr geehrter Kunde,

Um Ihnen das bestmögliche Produkterlebnis zu bieten, möchten wir Sie daran erinnern, Voltsoft auf die neueste verfügbare Version zu aktualisieren.

Die neueste verfügbare Version finden Sie auf www.conrad.de auf der zugehörigen Produktseite unter dem Reiter „Dokumente & Downloads“.

Sollten Sie Fragen zum Software-Update haben, so steht Ihnen unser Technischer Support unter folgender Anschrift und Telefonnummer zur Verfügung:

Voltcraft®, 92242 Hirschau, Lindenweg 15, Deutschland, Tel.: 0180 / 586 582 7.

Vielen Dank für Ihr Verständnis.

Ihr VOLTCRAFT-Team

Ⓧ Impressum

Dieser Hinweis ist eine Publikation von Voltcraft®, Lindenweg 15, D-92242 Hirschau, Tel.-Nr. 0180/586 582 7 (www.voltcraft.de).

Alle Rechte einschließlich Übersetzung vorbehalten. Reproduktionen jeder Art, z. B. Fotokopie, Mikroverfilmung, oder die Erfassung in elektronischen Datenverarbeitungsanlagen, bedürfen der schriftlichen Genehmigung des Herausgebers. Nachdruck, auch auszugsweise, verboten.

Dieser Hinweis entspricht dem technischen Stand bei Drucklegung. Änderung in Technik und Ausstattung vorbehalten.

© Copyright 2012 by Voltcraft®

V1_1212_02-JH

CE
VERSION 12/12

Ⓧ IMPORTANT NOTE

VOLTSOFT SOFTWARE

Dear Customer,

To provide you with the best possible product experience, we would like to remind you to update Voltsoft to the latest available version.

You will find the latest version at www.conrad.de on the respective product page, under the tab “Dokumente & Downloads” (“Documents & Downloads”).

If you have queries about the software update, our technical support is available under the following address and telephone number:

Voltcraft®, 92242 Hirschau, Lindenweg 15, Germany, phone +49 0180 / 586 582 7.

Thank you for your kind attention.

Your VOLTCRAFT team

CE
VERSION 12/12

Ⓧ Legal notice

This note is a publication by Voltcraft®, Lindenweg 15, D-92242 Hirschau/Germany, Phone +49 180/586 582 7 (www.voltcraft.de).

All rights including translation reserved. Reproduction by any method, e.g. photocopy, microfilming, or the capture in electronic data processing systems require the prior written approval by the editor. Reprinting, also in part, is prohibited.

This note represents the technical status at the time of printing. Changes in technology and equipment reserved.

© Copyright 2012 by Voltcraft®

V1_1212_02-JH

VOLTCRAFT®

Ⓡ REMARQUE IMPORTANTE

LOGICIEL VOLTSOFT

Chère cliente, cher client,

Afin de vous offrir la meilleure expérience produit possible, nous souhaiterions vous rappeler de mettre à jour Voltsoft vers la version la plus récente.

Vous trouverez la nouvelle version disponible sur www.conrad.de dans la page produit correspondante, sous l'onglet « Dokumente & Downloads » (« Télécharger les notices »).

Pour toute question sur notre mise à jour logicielle, notre assistance technique se tient à votre disposition à l'adresse et au numéro de téléphone suivants :

Voltcraft®, 92242 Hirschau, Lindenweg 15, Allemagne, Tél. +49 0180 / 586 582 7.

Merci de votre attention.

Votre équipe VOLTCRAFT

Ⓡ Informations légales

Cette remarque est une publication de la société Voltcraft®, Lindenweg 15, D-92242 Hirschau/Allemagne, Tél. +49 180/586 582 7 (www.voltcraft.de).

Tous droits réservés, y compris de traduction. Toute reproduction, quelle qu'elle soit (p. ex. photocopie, microfilm, saisie dans des installations de traitement de données) nécessite une autorisation écrite de l'éditeur. Il est interdit de le réimprimer, même par extraits.

Cette remarque correspond au niveau technique du moment de la mise sous presse. Sous réserve de modifications techniques et de l'équipement.

© Copyright 2012 by Voltcraft®

V1_1212_02-JH

CE
VERSION 12/12

VOLTCRAFT®

ⓃL BELANGRIJKE INFORMATIE

VOLTSOFT SOFTWARE

Geachte klant,

Om het best mogelijke meetresultaat te verkrijgen, wordt aangeraden om Voltsoft op te waarderen naar de meest recente versie.

De laatste versie staat op www.conrad.de op de bijbehorende productpagina in de rubriek "Dokumente & Downloads" ("Documenten & downloads").

Voor vragen over de software-update staat onze technische dienst beschikbaar onder het volgende adres en telefoonnummer:

Voltcraft®, 92242 Hirschau, Lindenweg 15, Duitsland, tel.: +49 0180 / 586 582 7.

Dank u voor uw aandacht.

Uw VOLTCRAFT-team

CE
VERSIE 12/12

ⓃL Colofon

Deze informatie is een publicatie van de firma Voltcraft®, Lindenweg 15, D-92242 Hirschau/Duitsland, Tel. +49 180/586 582 7 (www.voltcraft.de).

Alle rechten, vertaling inbegrepen, voorbehouden. Reproducties van welke aard dan ook, bijvoorbeeld fotokopie, microverfilming of de registratie in elektronische gegevensverwerkingsapparatuur, vereisen de schriftelijke toestemming van de uitgever. Nadruk, ook van uittreksels, verboden.

Deze informatie voldoet aan de technische stand bij het in druk bezorgen. Wijziging van techniek en uitrusting voorbehouden.

© Copyright 2012 by Voltcraft®

V1_1212_02-JH